

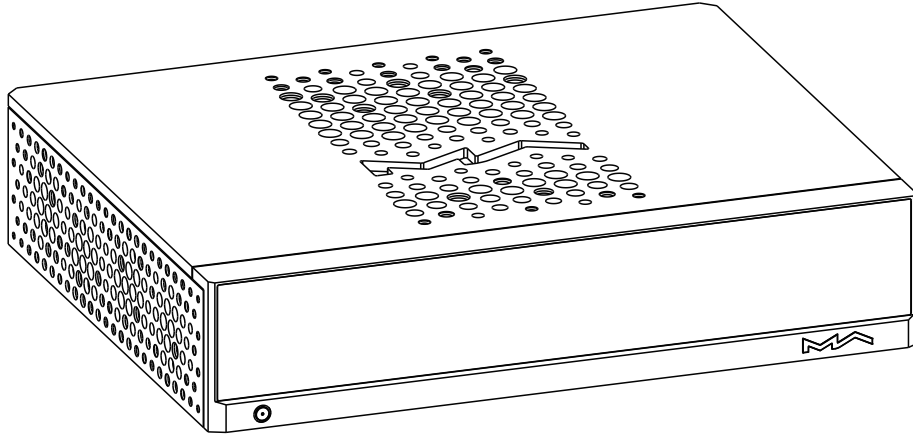

MS - 1 User Manual

M u s i c S t r e a m e r

Packing list.....	01
Parts and names.....	02
Front.....	02
Rear.....	03
Bottom.....	04
Remote control.....	05
Operations before using.....	06
Connect to Network.....	06
Connect to external clock.....	06
MA Remote App.....	06
Driver for USB Audio.....	07
Appendix.....	08
Digital Input.....	08
Digital Output.....	08
Analog input.....	08
Line output.....	08
Preamplifier output.....	08
Network.....	08
USB.....	08
External clock input.....	08
Trigger.....	08
Storage Extension.....	08
MA Player.....	08
Power.....	09
Weight & size.....	09
About MQA.....	09
About Spotify.....	09



Product

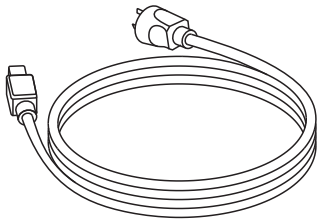

Power cable

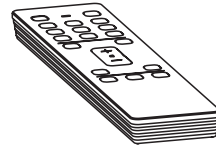

RM4B Remote control



User manual & warranty card

Front

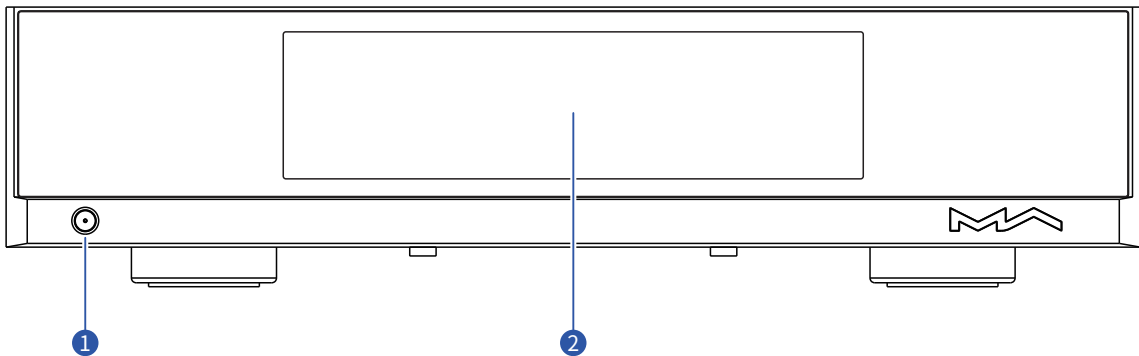

1 Power on/Standby

After connecting to power supply, press this button to power the device on, press it again to let the device standby. It will take about 30 seconds for the first start up after connecting to the power supply every time.

2 LCD screen

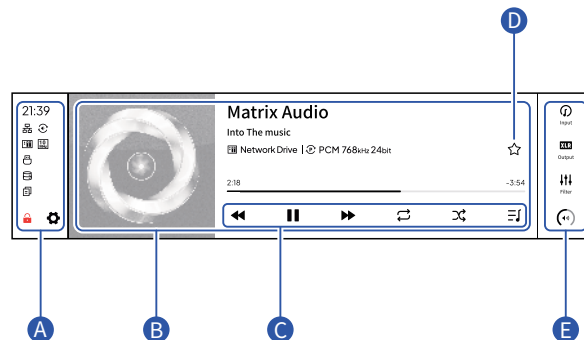

A Status bar

Status info : Status including time, network connection, storage device, NAS and hardware functions.
Settings button: Tap on this button to enter the "Settings" menu and change the options of the device.

B Information of audio

Including album art, track title, artist, duration, audio format, sampling rate and the filter type being used.

C Playback control buttons

With these buttons, you can control the playback, enable and disable loop and shuffle, check the play queue and the playlists.

D My favorites button

Add tracks to My favorites or remove tracks from My favorites by tapping on this button.

E Control bar

Input channel : Select the input channel.

Output channel (only for MS-1 Pre) : Select the output channel.

Filters : Select the audio filter types.

Volume and mute : Change the volume of pre outs, enable or disable mute for line outs or pre outs.

Rear

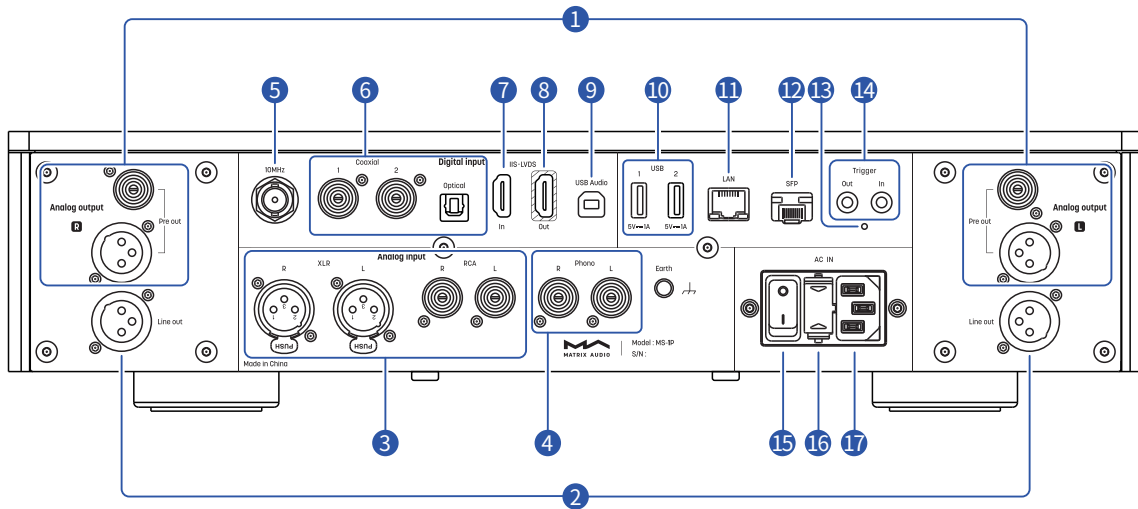

- 1 Pre-amplifier output (only for MA-1 Pre)**
Output level adjustable. Active speakers or amplifiers can be connected through these ports.
- 2 Line output**
Output level fixed. Recording or monitoring devices can be connected through these ports.
- 3 Analog input**
Connect to analog output devices through RCA or XLR cables.
- 4 Phono input**
Connect the phono output ports of vinyl turntables to the device through RCA cables. MS-1 supports MC and MM cartridges. Please select what type of cartridge you are using from the MA Remote App.
- 5 External clock input**
To use external clock input, connect the external clock source to the device through a coaxial cable with 50Ω impedance. Then turn to the settings menu from the device and choose "External clock".
- 6 Optical & coaxial input**
Connect to front-end devices with S/PDIF outputs through optical or coaxial cables.
- 7 IIS-LVDS input**
Connect to digital interfaces by Matrix Audio or other compatible devices through standard HDMI cables. The device has 4 kinds of IIS-LVDS pin definitions, which can be viewed and configured in the MA Remote App.
- 8 IIS-LVDS output**
Output the audio signal being played. You can connect an external DAC to this port, and the MS-1 will work as a digital audio transport. The device has 4 kinds of IIS-LVDS pin definitions, which can be viewed and configured in the MA Remote App.
- 9 USB Audio**
Connect to a PC through USB A to B cable, MS-1 will work as an external sound card of the PC.

Connect to a smartphone or tablet through USB C to B cable, MS-1 will work as an external sound card of the phone or tablet.

- 10 USB**
Connect to USB storage devices or CD drives. Each USB ports provide a maximum 5V/1.5A power.
- 11 Ethernet**
Connect to LAN port of the network router, the connection supports Gigabit transmission.
- 12 SFP port**
SFP optical and SFP RJ45 modules can be plugged into this port. The connection supports Gigabit transmission.
- 13 Reset button**
Only use this button when the unit works incorrectly, the unit can be reset to factory state. Please operate under the instructions by service team from Matrix Audio.
- 14 Trigger input/output**
Connect to audio devices with trigger ports through ø3.5mm mono plug cables, to achieve linkage control between the element device and other devices. The trigger output provides a 12V DC signal. When connecting MS-1 to MP-1 by a ø3.5mm stereo plug cable, and enable "Advanced control" from the settings menu of MS-1. You'll be able to control volume, input and output channels of MP-1 through MA-Remote App.
- 15 Power input**
Please use a power cable which includes an earth wire and ensure you have a reliable earth wire connection. Otherwise, the casing of the device may have a slightly charged touch.
- 16 Power switch**
If you need the device to be turned off completely, please turn off this switch. Otherwise, there is still about 1W power consumption in standby mode.
- 17 Fuse holder**
Please use a 5x20mm time-delay fuse.

*When connecting Apple devices which has a Lightning port to MS-1, you'll need a Lightning to USB Camera Adapter. Due to the hardware difference between Android devices, we can't ensure MS-1 is compatible with all the Android devices.

底部

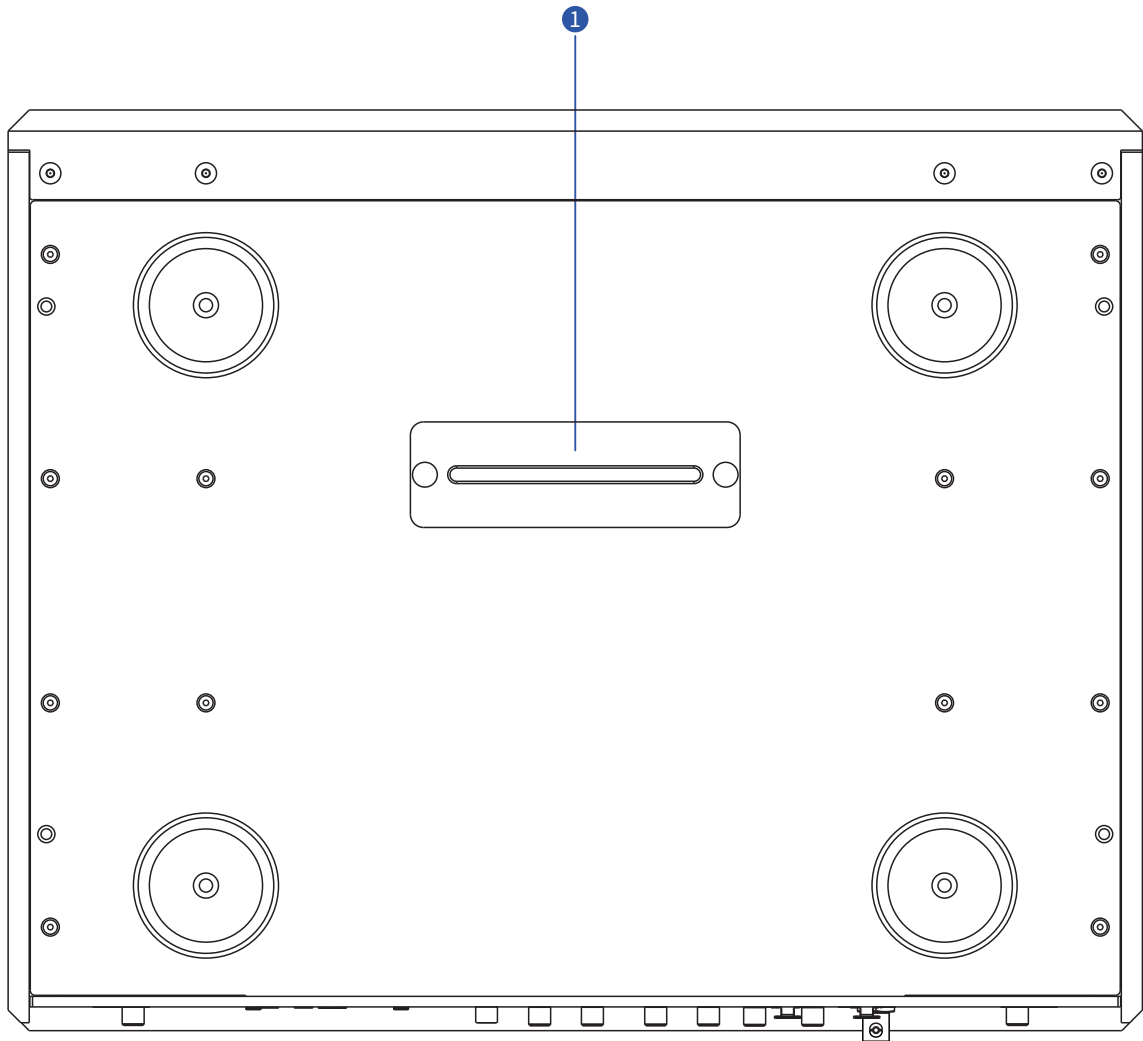

- 1 SSD slot
An M.2 NVMe SSD can be installed here as the internal storage of the device.

Remote Control

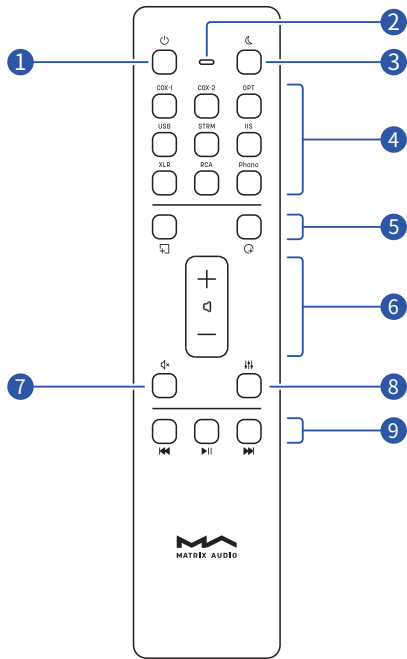

Slide in the direction of the arrow to open the battery holder. Please pay attention to the polarity when installing the batteries.

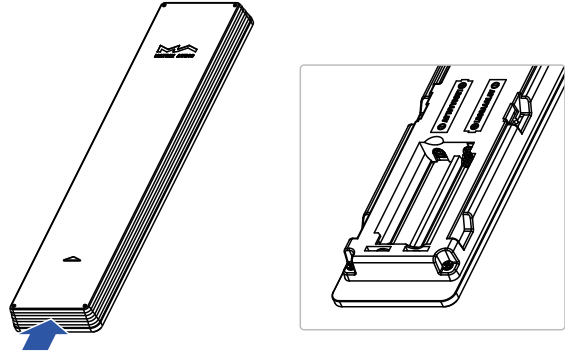

Point the remote control to the element device when using it, the operating distance is about 8 meters. When the battery is low, the LED indicator on the remote control flashes red, there will also be a notification showing on the device screen.

If there are more than one Matrix Audio device in a single environment, in order to prevent 1 remote control from controlling multiple devices at the same time, we preset 5 address codes in the remote control, these address codes can be configured in the Settings menu showing below, and follow the instructions on the screen.

- 1 Power on/Standby
- 2 Working/Battery status
- 3 Dimmer
- 4 Input channels
- 5 Programmable buttons
Define the functionalities of the programmable buttons through MA Remote App, these buttons are not defined by default.
- 6 Volume
- 7 Mute/Unmute
Press to mute, press again to unmute. You also can unmute by pressing the volume +/- buttons in mute state.
- 8 Filters
Switch the corresponding filter types applied to the current playing audio format in a loop.
- 9 Playback control area
When the input channel supports, the playback can be controlled by these buttons.

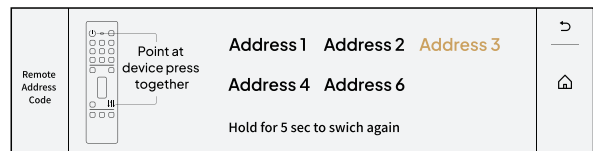

Connect to Network

LAN

Connect the product to the LAN port of the network router through an Ethernet cable. It is recommended to set up the router as a DHCP server, the device will be assigned an IP address automatically. Select "LAN" in option Network in Settings menu, you can configure the network specs manually, after joining the network, there will be an  icon shown in the status bar.

When the connection has no Internet access, there will be an  icon in the status bar.

SFP

Plug an SFP optical module or an SFP to RJ45 module, you'll be able to connect the device to network via optical or Ethernet cables. It is recommended to set up the router as a DHCP server, the device will be assigned an IP address automatically. Select "SFP" in option Network from Settings menu, you can configure the network specs manually, after joining the network, there will be an  icon shown in the status bar.

When the connection has no Internet access, there will be an  icon in the status bar.

Connect to external clock

If you want to use an external clock source, connect the external clock to the MS-1 through a 50Ω impedance coaxial cable, select "External clock" in the device settings menu. It supports 10MHz sine wave or square wave input. When the device detects an external clock signal, the icon  will be displayed on the status bar. When the option Reference Clock is set to "External Clock" while the clock device is not connected, music will not be played.

MA Remote App

Install MA Remote App for your iPad, iPhone or Android phone.



Open the App, follow the instructions to add the device to MA Remote App.



To control and configure the element devices through MA Remote App, or playback streaming music from the device, please refer to matrix-digi.com/tutorials for instructions.



Tutorial Video

Driver for USB Audio

When connecting the devices to a Windows 7/8/10/11 computer via USB connection as an external audio device, please install drivers as following instructions:

1. Double-click the driver installation package and click "Next".

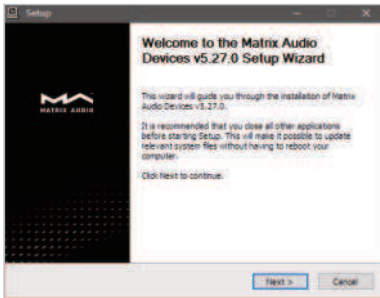

2. Select installation path and click "Install".

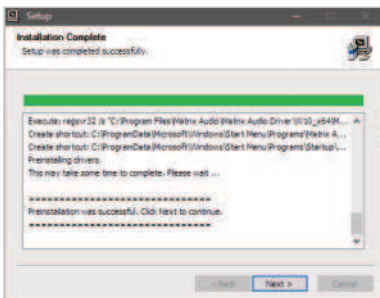

3. Click "Next" after the installation is complete.

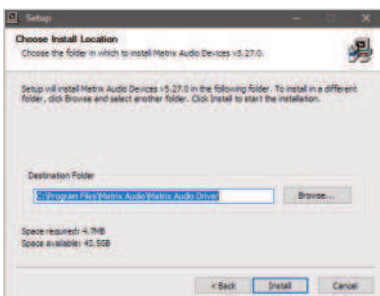

4. Click "Finish" to close the Setup Wizard.

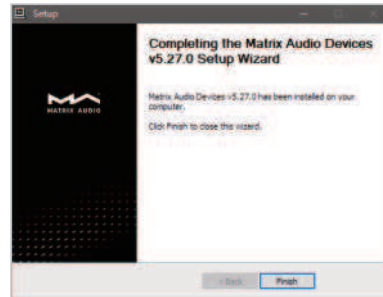

It's no need to install drivers for macOS, just select "Matrix Audio" as the audio output device in Sound Preferences.



Technical Specifications

Digital Input

Coaxial & Optical

PCM 16-24Bit/44.1kHz, 48kHz, 8.2kHz, 96kHz, 176.4kHz, 192kHz
DSD 2.82MHz, 3.07MHz (DoP)

IIS LVDS

PCM 16-32Bit/44.1kHz, 48kHz, 88.2kHz, 96kHz, 176.4kHz,
192kHz, 352.8kHz, 384kHz, 705.6kHz, 768kHz
DSD 2.82MHz, 3.07MHz, 5.64MHz, 6.14MHz,
11.29MHz, 12.29MHz (DoP)
DSD 2.82MHz, 3.07MHz, 5.64MHz, 6.14MHz,
11.29MHz, 12.29MHz, 22.58MHz, 24.58MHz,
45.16MHz, 49.15MHz (Native)

USB Audio

PCM 16-24Bit/44.1kHz, 48kHz, 88.2kHz, 96kHz, 176.4kHz,
192kHz, 352.8kHz, 384kHz, 705.6kHz, 768kHz
MQA 16-24Bit/44.1kHz, 48kHz, 88.2kHz, 96kHz, 176.4kHz,
192kHz, 352.8kHz, 384kHz MQA or MQA Studio stream
DSD 2.82MHz, 5.64MHz, 11.29MHz (DoP)
DSD 2.82MHz, 3.07MHz, 5.64MHz, 6.14MHz, 11.29MHz, 12.29MHz,
22.58MHz, 24.58MHz (Native)

Digital Output

IIS-LVDS

PCM 16-32Bit/44.1kHz, 48kHz, 88.2kHz, 96kHz, 176.4kHz,
192kHz, 352.8kHz, 384kHz, 705.6kHz, 768kHz
DSD 2.82MHz, 3.07MHz, 5.64MHz, 6.14MHz, 11.29MHz, 12.29MHz,
22.58MHz, 24.58MHz, 45.16MHz, 49.15MHz (Native)

Aux Input

XLR

Input Impedance: 40k Ω
SNR: 118dB A-weighting
THD+N: <0.00026%@1k, <0.00030%@20Hz-20kHz
Frequency Response: 20Hz-20kHz \pm 0.3 -3dB@46kHz
Crosstalk: >-135dB
Input Level: 4.9VRMS Maximum

RCA

Input Impedance: 20k Ω
SNR: 110dB A-weighting
THD+N: <0.00060%@1k, <0.00100%@20Hz-20kHz
Frequency Response: 20Hz-20kHz \pm 0.3 -3dB@46kHz
Crosstalk: >-125dB
Input Level: 2.35VRMS Maximum

Phono

MM Mode
Input Impedance: 47k Ω /100pF
Gain: +45dB
MC Mode
Input Impedance: 100 Ω
Gain: +65dB

Line Output

XLR

Output Impedance: 20 Ω
Output Level: 5VRMS Fixed
SNR: 129dB A-weighting
THD+N: <0.00020%@1k, <0.00025%@20Hz-20kHz
Frequency Response: 20Hz-20kHz \pm 0.3 -3dB@83kHz
Crosstalk: >-145dB

Pre Output

XLR

Output Impedance: 40 Ω
Output Level: 0~16VRMS Adjustable
Gain: +10dB
SNR: 126dB A-weighting
THD+N: <0.00020%@1k, <0.00025%@20Hz-20kHz
Frequency Response: 20Hz-20kHz \pm 0.3 -3dB@83kHz
Crosstalk: >-145dB

RCA

Output Impedance: 16 Ω
Output Level: 0~8VRMS Adjustable
Gain: +10dB
SNR: 126dB A-weighting
THD+N: <0.00020%@1k, <0.00025%@20Hz-20kHz
Frequency Response: 20Hz-20kHz \pm 0.3 -3dB@83kHz
Crosstalk: >-140dB

Network

LAN : 10/100/1000 Mbps
SFP : 10/100/1000 Mbps

USB

USB 3.0 x 2
The USB port provides a maximum power of 5V/1.5A.

The USB port works with devices which conform to the USB mass storage standard and supports FAT, FAT32, exFAT, and NTFS file formats, but is not guaranteed to be compatible with all storage devices.

External Clock Input

10MHz / 50 Ω / Sine wave or square wave input

Trigger

Trigger in : DC 6-12V <10mA
Trigger out : DC 12V/50mA

Storage Extension

M.2 2280 NVMe PCIe SSD slot *1

MA Player

Controller app: MA Remote App

Local Playback:

Format Supported

MP3, WMA, WAV, AIF, AIFC, AIFF, AAC, FLAC, OGG, APE, ALAC, M4A, DSF, DFF, CUE

PCM 16-24Bit/44.1kHz, 48kHz, 88.2kHz, 96kHz, 176.4kHz, 192kHz, 352.8kHz, 384kHz, 705.6kHz, 768kHz

MQA 16-24Bit/44.1kHz, 48kHz, 88.2kHz, 96kHz, 176.4kHz, 192kHz, 352.8kHz, 384kHz
MQA or MQA Studio stream

DSD 2.82MHz, 3.07MHz, 5.64MHz, 6.14MHz, 11.29MHz, 12.29MHz, 22.58MHz, 24.58MHz

Roon Ready

PCM 16-24 Bit /44.1kHz, 48kHz, 88.2kHz, 96kHz, 176.4kHz, 192kHz, 352.8kHz, 384kHz, 705.6kHz, 768kHz

MQA 16-24Bit/44.1kHz, 48kHz, 88.2kHz, 96kHz, 176.4kHz, 192kHz, 352.8kHz, 384kHz MQA or MQA Studio stream

DSD 2.82MHz, 5.64MHz, 11.29MHz, 22.58MHz

AirPlay2, DLNA/UPnP, TIDALConnect, SpotifyConnect, vTuner, Radio Paradise, the audio specs depend on the service provider.

Power Specs

Power Voltage: AC 100V-120V 50/60Hz or AC 220V-240V 50/60Hz, factory-fixed

Standby Power Consumption: < 5W

Maximum Power Consumption: < 60W

Weight & size

Weight: 14.6kg (32.2 pounds)



Size: Width: 430 mm (16.93 inches)

Depth: 353 mm (13.90 inches)

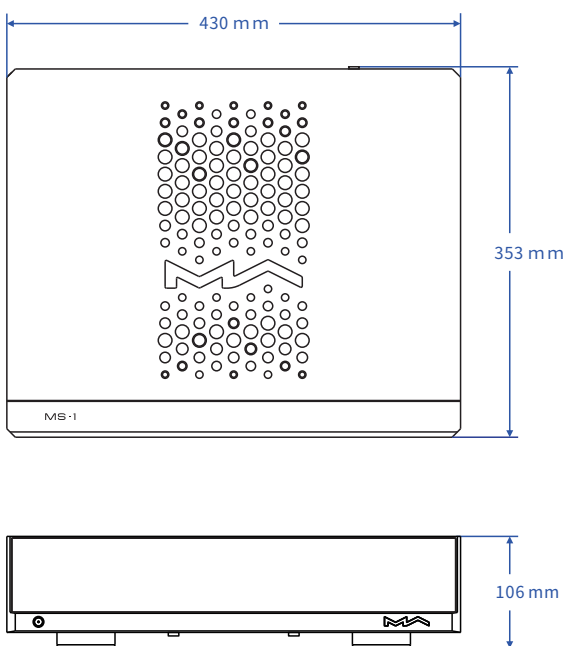
Height: 106 mm (4.17 inches)

**About MQA**

This unit includes a MQA full decoder, which enables you to playback MQA audio files via streaming or USB audio port, delivering the sound of the original master recording.

The dots beside the MQA logo green  or blue  to indicate that the unit is decoding and playing an MQA stream or file, and denotes provenance to ensure that the sound is identical to that of the source material. It glows blue  to indicate it is playing an MQA Studio file, which has either been approved in the studio by the artist/producer or has been verified by the copyright owner.

The dot glows magenta  to indicate that the unit is rendering an MQA stream or file. This delivers the final unfold of the MQA file.

*MQA and the Sound Wave Device are registered trade marks of MQA Limited. ©2016

About Roon Ready

Being Roon Ready means that Matrix Audio music streamers transparently discover and connect to Roon without any configuration, and bit-perfect audio is delivered from Roon to your music streamer.

About Spotify

Use your phone, tablet or computer as a remote control for Spotify. Go to spotify.com/connect to learn how.

The Spotify Software is subject to third party licenses found here:

<https://www.spotify.com/connect/third-party-licenses>.

This product is for indoor use only.

For full ventilation, it is recommended to reserve a space of larger than 5 cm around the device.

Do not cover the air vents with stuffs such as papers, tablecloths, and curtains to obstruct ventilation.

Do not place stuff with flame, such as lighted candles, on the device.

If the device is used in tropical areas, please be careful to prevent insects from entering the unit through the air vents.

The device must not be subject to water droplets or splashes. Please do not place stuffs filled with liquids such as vases and cups on or near the device.



西安矩阵电子科技有限公司
Matrix Electronic Technology Co., LTD

🌐 matrix-digi.com

☎ +86-29-86211122

📍 陕西省西安市经济技术开发区明光路58号龙腾半导体产业园B栋206室
Room 206 Block B, #58 Mingguang Road Xi'an, Shaanxi

PGYA001V1.2